

# *Psychic Sarah*

(For Stand Type)

## **User Manual**

[ English ]

FUSENCE CO., LTD

---

# [ Japan&Usa Coin Acceptor Board ]

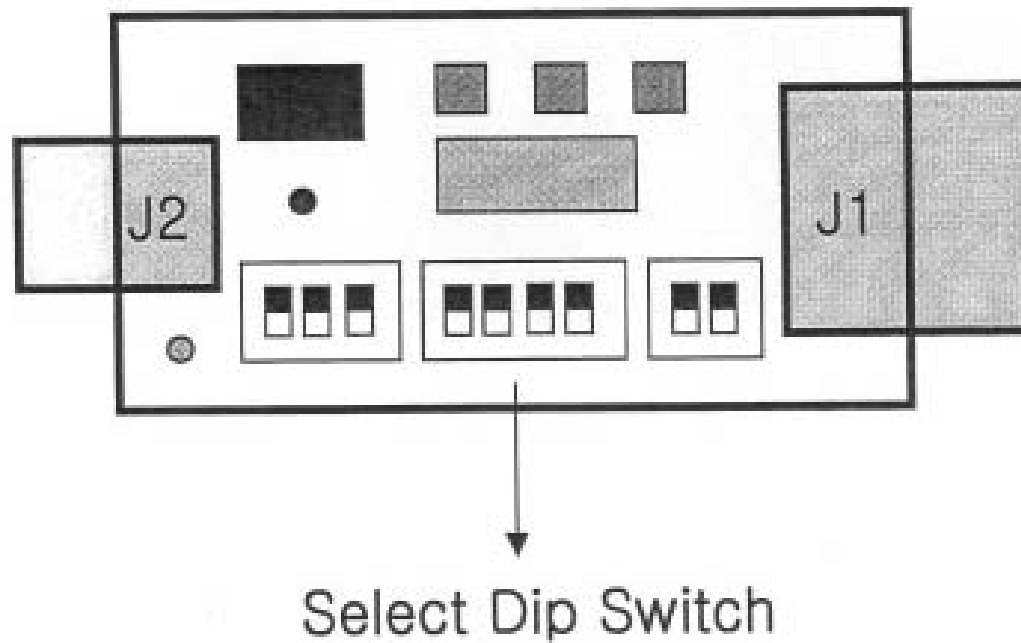



- Paper sensor

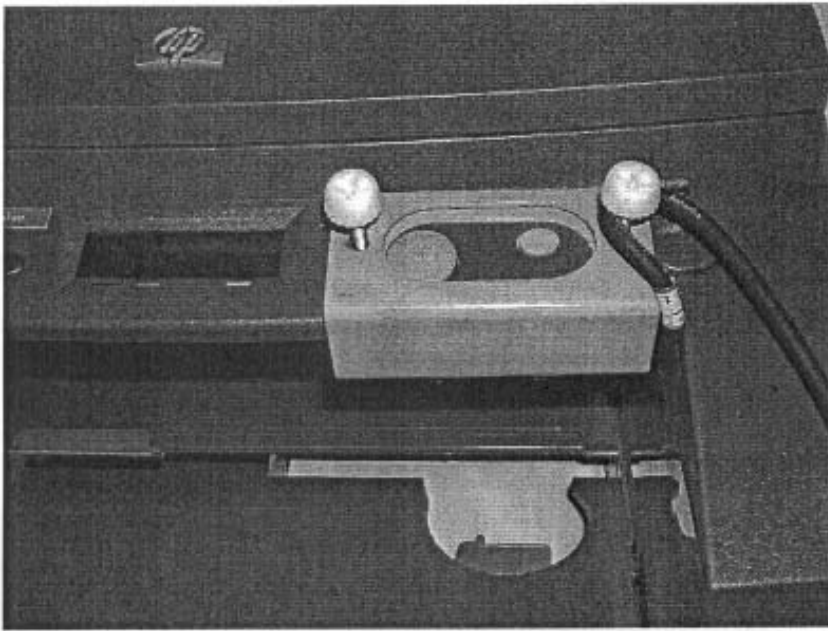

- Speaker volume & Control button



Speaker volume

Control button  
(button  $\leftrightarrow$  Control board)

COIN(BLUE)	SETUP(YELLOW)	PARK(RED)	RESET(WHITE)
SERVICE COIN	PROGRAM SETTING	PC PARKING	CONTROL BOARD RESET

- Control board

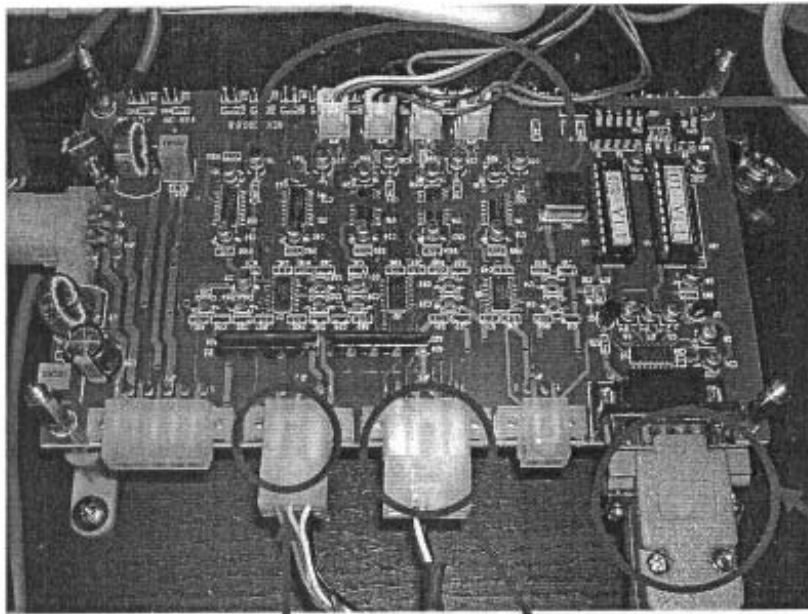

Control button  
(board ↔ button)

COM 2  
(PC ↔ Control board)

Coin cable  
→ Sensor board  
Red → DC 12V  
White → Signal  
Black → GND  
Green → GND

Start button

- Top billboard lamp controller

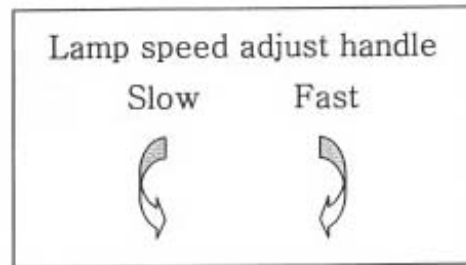
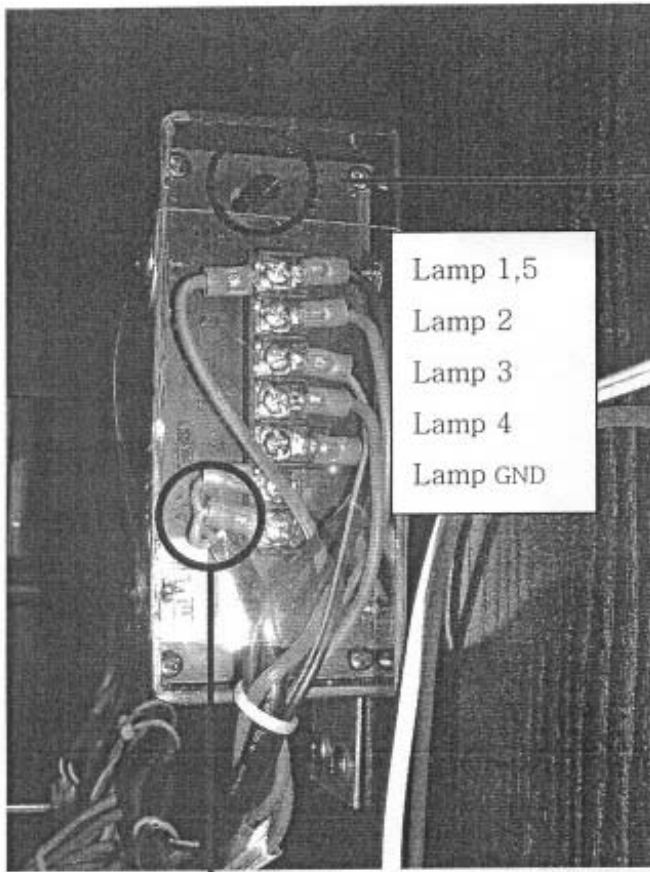

INPUT : AC 230V

- Aura sensor board

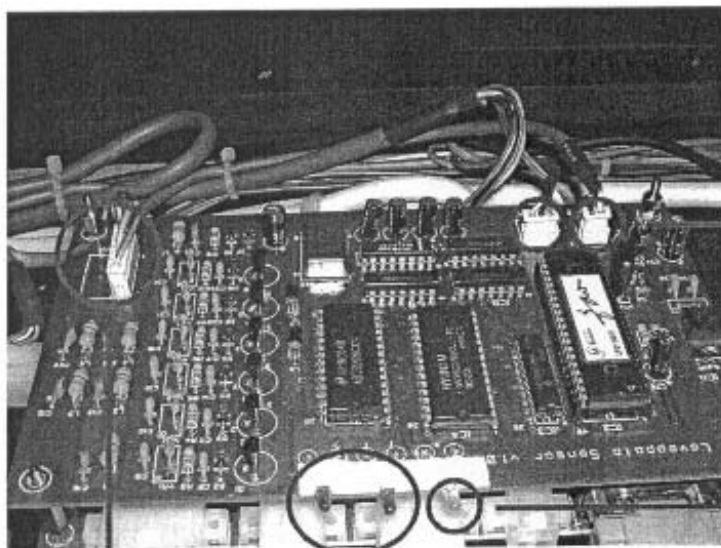

COM 1  
(PC ↔ Aura board)

INPUT : DC 12V

DC LED

Sensor plate

RX.TX

● Circuit breaker & SMPS Power

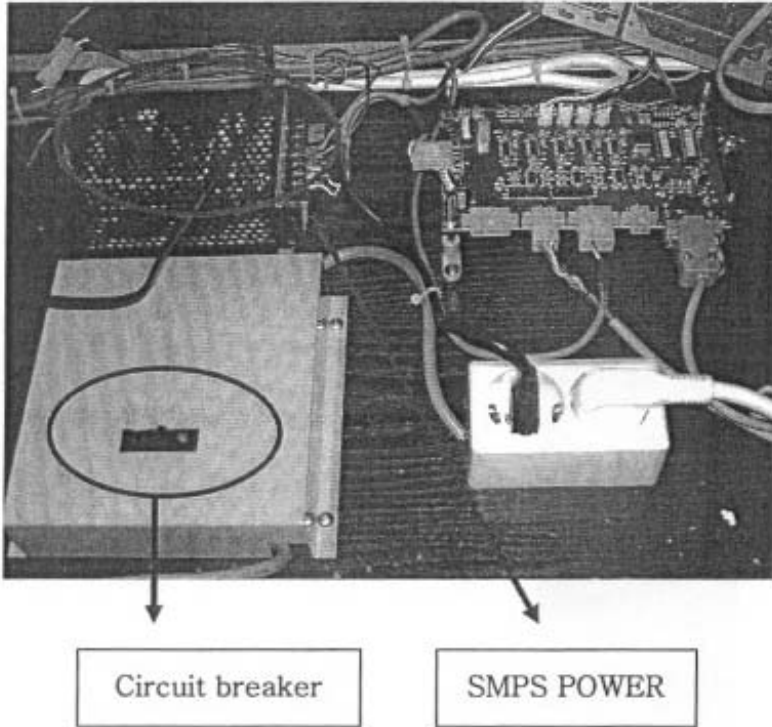

● Sensor board

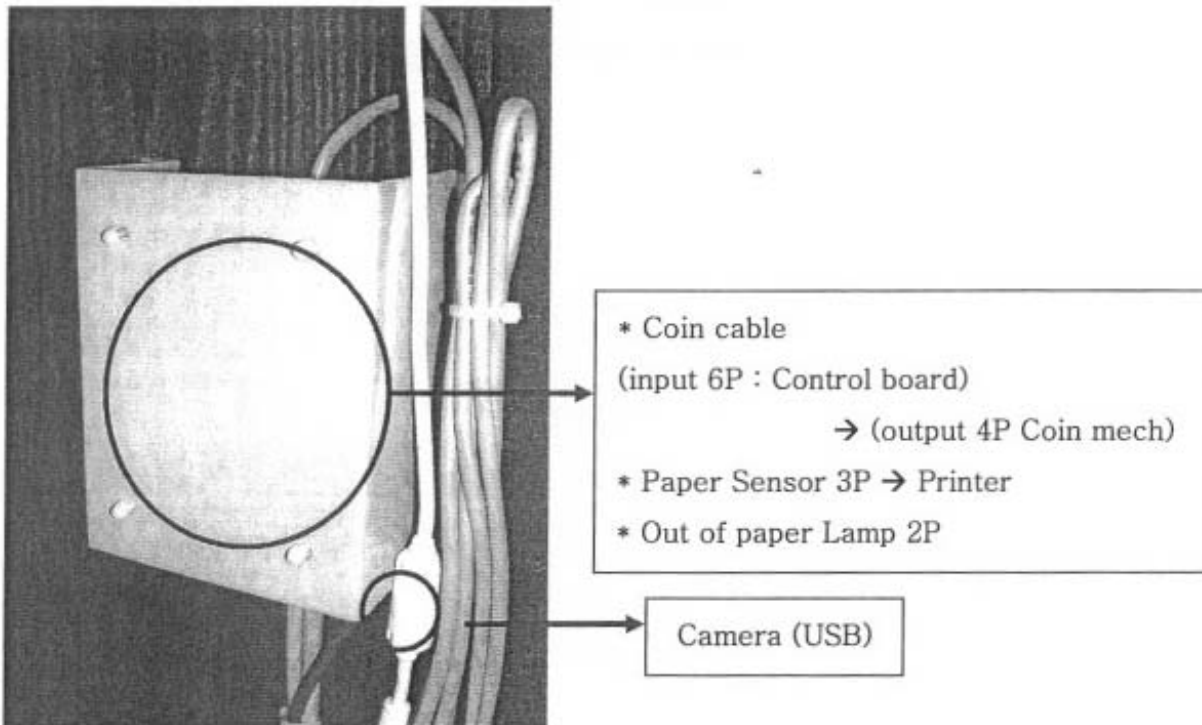

● Circuit breaker & SMPS Power

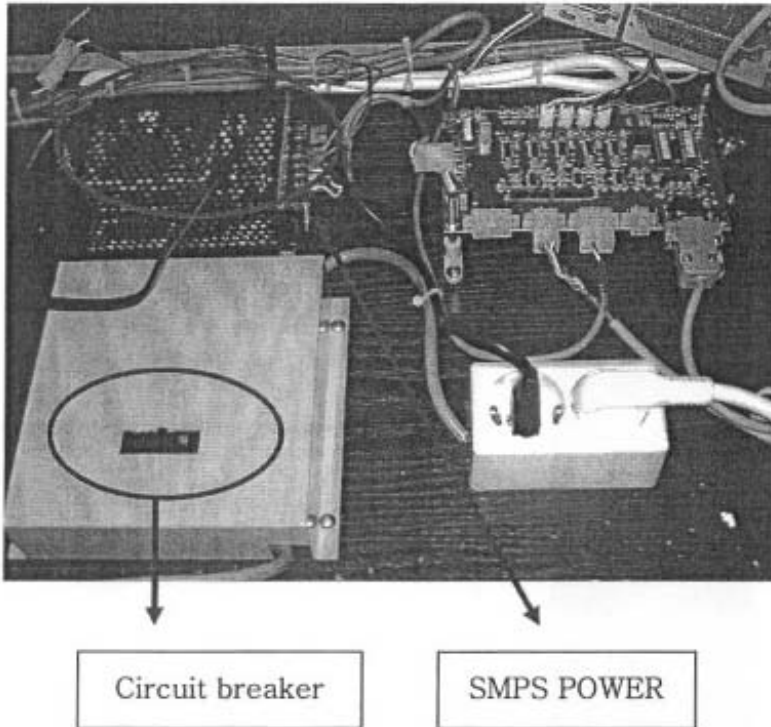

● Sensor board

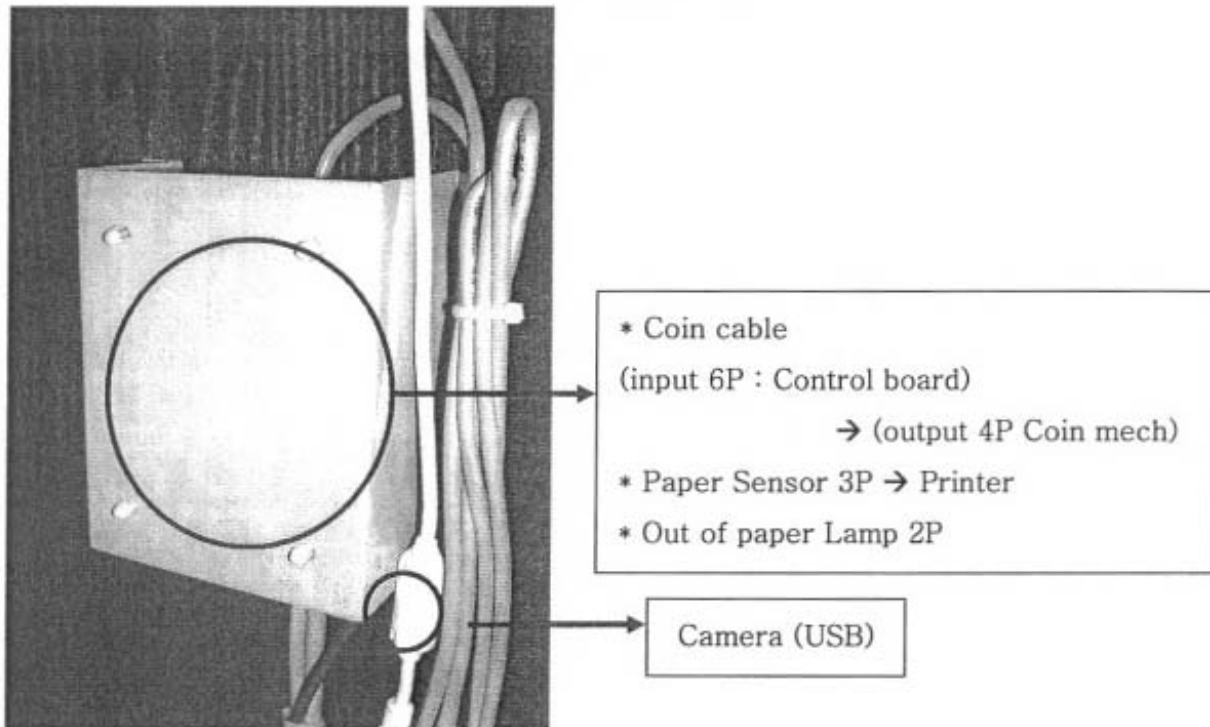

● PC System

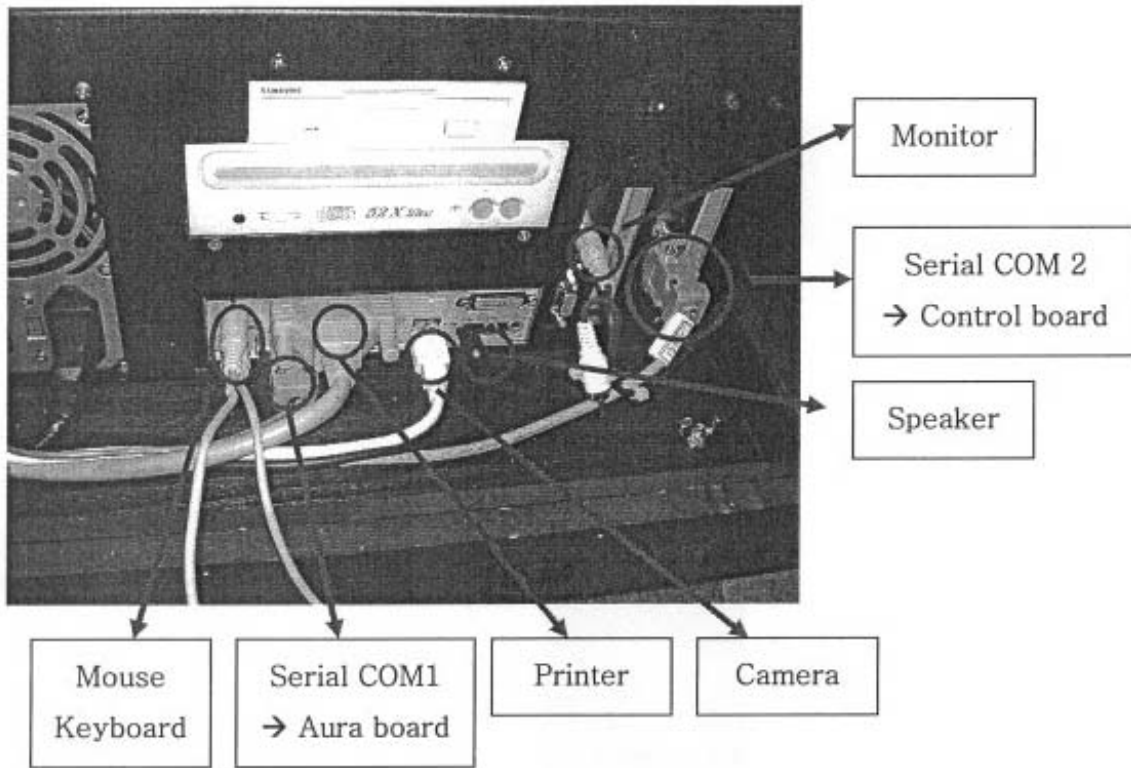

● Display LAMP Control Board

